

PRODUCT SPECIFICATIONS

Elkay Lustertone™ Classic Stainless Steel 15" x 15" x 6-1/8", Single Bowl Drop-in Bar Sink. Sink is manufactured from 18 gauge 304 Stainless Steel with a Lustrous Satin finish, Center drain placement, and Bottom only pads.

Installation Type:	Drop-in
Material:	304 Stainless Steel
Finish:	Lustrous Satin
Gauge:	18
Sound Deadening:	Bottom only pads
Number of Bowls:	1
Sink Dimensions:	15" x 15" x 6-1/8"
Bowl 1 Dimensions:	12" x 9-1/4" x 6"
Drain Size:	2" (51mm)
Drain Location:	Center
Minimum Cabinet Size:	18"
Mounting Hardware:	Part # 64090008 included for countertops up to 3/4" (19mm) thick
Template Included:	No
Cutout Template #:	1000001240

Template is available for download at [elkay.com](#). CAD software will be required to open the template.

Cutout Dimensions for Drop-in Installation:
14-3/8" x 14-3/8" (365mm x 365mm) with 1-1/2" (38mm) corner radius

Custom Options	
<input type="checkbox"/> Type 316 Stainless Steel	
Drain Location	
<input type="checkbox"/> Right Rear	<input type="checkbox"/> Left Rear
<input type="checkbox"/> Center	<input type="checkbox"/> Center Rear
Overflow Location	
<input type="checkbox"/> Front	<input type="checkbox"/> Rear
Alternate Punching	
<input type="checkbox"/> Faucet Model:	<input type="checkbox"/> Punch Required:
Sink Size	
<input type="checkbox"/> Bowl Depth:	<input type="checkbox"/> Drainboard Width:



A Century of Tradition and Quality. For more than 100 years, Elkay has been making innovative products and providing exceptional customer care. We take pride in offering plumbing products that make life easier, inspire change and leave the world a better place.



Product Compliance: ADA & ICC A117.1
ASME A112.19.3/CSA B45.4
Buy American Act



Sinks are listed by IAPMO® as meeting the applicable requirements of the Uniform Plumbing Code®, International Plumbing Code®, and National Plumbing Code of Canada.



Complies with ADA & ICC A117.1 accessibility requirements when installed according to the requirements outlined in these standards.

[Clean and Care Manual \(PDF\)](#)
[Installation Instructions \(PDF\) - 100005236](#)
[Warranty \(PDF\)](#)

Similar models are available with: Quick-Clip Mounting System

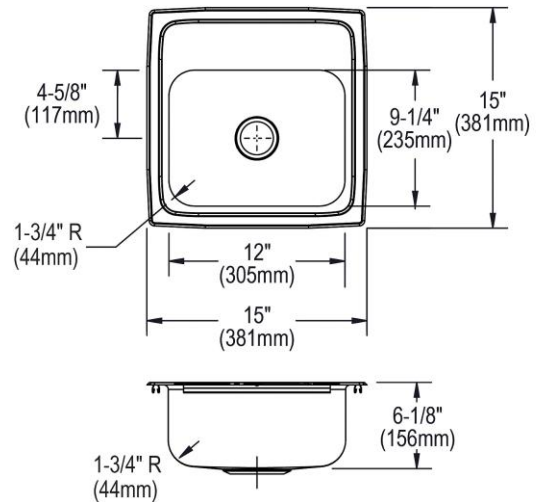







PART: _____ QTY: _____
PROJECT: _____
CONTACT: _____
DATE: _____
NOTES: _____
APPROVAL: _____

In keeping with our policy of continuing product improvement, Elkay reserves the right to change product specifications without notice. Please visit [elkay.com](#) for the most current version of Elkay product specification sheets. This specification describes an Elkay product with design, quality, and functional benefits to the user. When making a comparison of other producers' offerings, be certain these features are not overlooked.

Installation Profile:



Optional Accessories		
LKWBG1209SS	Elkay Stainless Steel 11" x 8" x 1" Bottom Grid Spec Sheet (PDF)	
CB912	Elkay Hardwood 12-7/8" x 10-1/8" x 1" Cutting Board Spec Sheet (PDF)	
LK36	Elkay Drain Fitting 2" Nickel Plated Brass Body with Deep Stainless Steel Strainer Basket Spec Sheet (PDF)	
LKGT1042CR	Elkay Gourmet Single Hole Bar Faucet Pull-out Spray and Lever Handle Chrome Spec Sheet (PDF)	
LKGT1042NK	Elkay Gourmet Single Hole Bar Faucet Pull-out Spray and Lever Handle Brushed Nickel Spec Sheet (PDF)	
LKGT1042RB	Elkay Gourmet Single Hole Bar Faucet Pull-out Spray and Lever Handle Oil Rubbed Bronze Spec Sheet (PDF)	
LKW RB1209SS	Elkay Stainless Steel 8" x 11" x 7" Rinsing Basket Spec Sheet (PDF)	

In keeping with our policy of continuing product improvement, Elkay reserves the right to change product specifications without notice. Please visit elkay.com for the most current version of Elkay product specification sheets. This specification describes an Elkay product with design, quality, and functional benefits to the user. When making a comparison of other producers' offerings, be certain these features are not overlooked.